

A GUIDE TO
Quantec
addressable call system



INDEX

WHAT IS QUANTEC?	3
Overview	3
Why have an addressable call system?	3
About this guide	3
SYSTEM OPERATION	4
Standard calls	4
Call accept	4
Staff presence	4
Call follower sounders (optional)	4
Reset	4
Help required/assistance calls	4
Emergency calls	4
Infrared staff attack calls (optional)	4/5
Day/Night mode	5
Automatic divert	5
Manual divert	5
Datalogging	5
Paging	5
NETWORK DEVICES	6
Call points	6
Monitoring points	6
Displays	7
Infrared ceiling receivers	7
Radio receivers	7
RF integrity transmitters	7
Addressable overdoor lights/addressable sounders	8
Quantec controller	8
ANCILLARY DEVICES	9
Slave overdoor lights	9
Ceiling pulls	9
Slave call points	9
Tail call buttons	9
Hand/foot operated pneumatic pads	9
Portable movement detectors	10
Dual-action infrared/radio transmitters	10
Configurator for dual-action infrared/radio transmitters	10
PLANNING AN INSTALLATION	11
PLANNING THE WIRING	12
Example wiring overview	13
DEVICE DIMENSIONS	14
FURTHER INFORMATION	15

WHAT IS QUANTEC?

Quantec represents one of the biggest breakthroughs in call communication equipment for many years. It is a powerful yet easy to use addressable call system that puts the needs of its users (patients and staff) and the installer well and truly first.

The way the system operates can be tailored to suit a building's exact requirements with different day, night and call divert arrangements easily accommodated and, if required, simply changed at a later date.

This flexibility, coupled with many other advanced features such as four different call levels (plus an optional infrared staff attack facility), built-in datalogging and full monitoring of all network devices, makes Quantec the obvious choice for nursing homes, hospitals, health centres, leisure centres, prisons, government buildings and many other private and public sector establishments.

WHY HAVE AN ADDRESSABLE CALL SYSTEM?

As the type of establishments listed above have become larger and more specialised, demand has increased for call systems that operate in more sophisticated ways, i.e. different urgencies of calls, calls shown in different places at different times, sounders operating as quietly as possible, etc. These requirements can vary greatly and although it is possible to meet some of these demands with the careful planning of conventional call systems, conditions change and there is often some special request which cannot be easily accommodated once installation is complete.

The main advantage of addressable call systems over conventional systems is that they can be installed with very little planning and displays can be fitted virtually anywhere to suit the application. However, whilst simplifying things for the installer, some addressable systems still fail to satisfy the varied needs of the user. This is because they are essentially 'dumb' systems, i.e. call points send notification of a call onto the wiring, displays pick the information up and the message is shown everywhere.

Quantec is different. It is much more sophisticated than basic addressable systems but at the same time very easy for staff to use. Quantec's call points send notification of a call to the 'Quantec Controller' which passes the call only to pre-selected displays. What's more, should these arrangements need changing due to new working practices or alterations to the building's layout, they can be with the minimum of fuss.

In order to achieve this level of flexibility and allow the use of ordinary unscreened cable, Quantec utilises a unique data protocol which works down just two wires (power and data). This allows considerable cost savings on installation and means Quantec can be retrofitted to the wiring of many existing conventional call systems. The protocol allows up to 256 addressable devices (displays, call points, infrared ceiling receivers, etc) to be connected to a system together with virtually any number of 'slave' ancillary devices such as ceiling pulls and overdoor lights.

ABOUT THIS GUIDE

This guide provides a detailed overview of how the Quantec Addressable Call System works. It describes in simple terms the various Quantec devices that are available and provides straightforward advice on how to plan and wire an installation. Further information, if required, can be obtained from your distributor.

SYSTEM OPERATION

STANDARD CALLS

To trigger a call, the user presses the 'CALL' button on a wall-mounted call point, pulls the cord of a ceiling pull unit or operates the remote button of a tail call lead. This causes the call point's confidence light to pulse red slowly. Outside the room, sounders pulse slowly, overdoor lights (if fitted) pulse red slowly and all relevant displays show the exact location of the calling room.

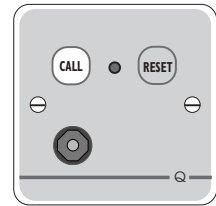

CALL ACCEPT

When a call is shown on several displays at the same time, several staff may respond simultaneously. To help prevent this happening, a member of staff can accept the call at a display by pressing its 'A' button. This will remove the call from all displays (but for safety reasons the call will return if it is not dealt with quickly).

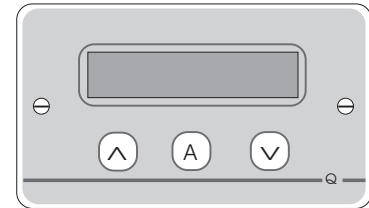

STAFF PRESENCE

When the member of staff arrives, the call point's 'RESET' button is pressed to cancel the call and to put the call point into Staff Presence mode. This causes the call point's confidence light to pulse green slowly. Outside the room overdoor lights (if fitted) pulse green slowly and all relevant displays show the location of the room where staff are present.

CALL FOLLOWER SOUNDERS (optional)

If fitted, low level sounders will sound at all call points in Staff Presence mode when the system is in NIGHT mode and a call occurs elsewhere. This helps reduce sound levels by quietly informing staff that other calls are waiting, prompting them to visit a display.

RESET

As the member of staff leaves the room the call point's 'RESET' button is pressed again to take it out of Staff Presence mode and returning it to normal. If preferred, magnetic reset call points can be used with magnetic reset keys (see **CALL POINTS, page 6**, for further details).

HELP REQUIRED (ASSISTANCE) CALLS

If assistance is required (but it is not an emergency), pressing the call point's 'CALL' button whilst it is in Standard Call or Staff Presence mode makes a Help Required call. This causes the call point's confidence light to pulse red more urgently than when a Standard call is made. Outside the room, sounders pulse more urgently, overdoor lights (if fitted) pulse red and a Help Required message appears on all relevant displays together with the location of the room where assistance is required. **Note:** repeated operation of a tail call button or ceiling pull will not initiate a Help Required call.

EMERGENCY CALLS

In an emergency, pressing the call point's 'CALL' and 'RESET' buttons together makes an Emergency call regardless of the previous state of the call point (unless in attack mode, see below). This causes the call point's confidence light to flash red and green. Outside the room, sounders pulse rapidly, overdoor lights (if fitted) flash red and green and an emergency message appears on all relevant displays together with the location of the calling room.

INFRARED STAFF ATTACK CALLS (optional)

To help combat the threat of verbal and physical abuse against members of staff, Quantec has an optional infrared staff attack facility which helps protect staff against disturbed patients, intruders and/or aggressive visitors. It works as follows:-



Designated staff carry an infrared transmitter which they attach to their uniforms. When an attack takes place, they activate the transmitter by pressing one of its buttons or releasing its retained pull clip to fill the area with infrared signals (QT412RXA transmitters only). These signals are received by a special infrared call point or ceiling receiver which instantly informs Quantec that an attack is taking place. An urgent, piercing alarm is sounded throughout the building (as programmed) and the exact location of the attack is indicated at all relevant displays, thus prompting the quick response of security staff.

For security reasons Attack calls can only be reset by entering a special code at the Quantec Controller or a Display with controls.

In addition to Attack calls, Quantec's infrared call points and ceiling receivers can generate other levels of call too. The type of call generated depends on the type of transmitter(s) and receiver(s) used (see pages 6, 7 and 10 for further details on infrared call points, ceiling receivers and transmitters).

All QT412 range transmitters have the ability to send radio as well as infrared calls. To generate a radio call, at least one Quantec radio receiver is required (see page 7 for details). Radio receivers are ideal for picking up calls in outside areas such as car parks and loading bays where infrared transmission is not practical.

DAY/NIGHT MODE

Night mode can be manually selected by the user or, if preferred, the commissioning engineer can allocate times at which the system will automatically enter and exit night mode. When in night mode, all calls are shown on all displays but only selected displays sound. This allows for lower staffing levels and reduced sound levels. Night mode can be backed up by the use of optional CALL FOLLOWER SOUNDERS in call points (see page 4).

AUTOMATIC DIVERT

If a call remains unanswered for a preset time (1-8 mins), to ensure it does not remain unattended indefinitely, the system can be set up to automatically divert it to other areas.

MANUAL DIVERT

If a member of staff leaves one area they can divert calls to another area via the controls on a display.

DATALOGGING

Quantec's built-in datalogger can record the date, time, type and location of every call and reset for output to an 80 column serial printer. Quantec Printer Kits (part no. QT600P) are available and include a printer, interface lead and connection socket. All kits are tested and calibrated with Quantec prior to despatch.

PAGING (optional)

Due to problems of misuse (paggers being dropped in the sluice, etc), we recommend the use of CALL FOLLOWER SOUNDERS and a larger number of displays as a reliable, practical alternative to paging. However, when paging must be used, the following options are available:

Tone Only Paging: a basic paging facility designed to indicate that a call has been raised. No priority is given to the level of incoming call, i.e. if a standard call is flagged before an emergency call, the pager will not show the emergency call until the standard call clears. Standard calls beep once and the number 1 is shown, Help Required calls beep twice and the number 2 is shown, Emergency and Attack calls beep three times and the number 3 is shown. To determine the exact location of a call, staff must visit a display.

Alphanumeric Radio Paging: this option allows call information from the Controller to be broadcast globally to alphanumeric paggers via a radio transmitter. It is possible to select which type of call(s) are transmitted to the paggers (i.e. emergency calls only) but different levels of calls cannot be prioritised. For example, if a standard call is triggered followed by an emergency call, the emergency call will not be displayed until the standard call has been accepted. (This is not the case at displays where different types of calls are still prioritised).

NETWORK DEVICES

Quantec's network devices are small, discreet and designed to blend into any sort of decor. Up to 256 network devices can be used per system, each containing a non-volatile memory to store its unique address identification number. Network devices consist of Call Points, Displays, Monitoring Points, Infrared Ceiling Receivers, Radio Receivers and Addressable Overdoor Lights. They do not include ancillary devices such as Slave Overdoor Lights or Ceiling Pulls.

CALL POINTS

Quantec's call points have two buttons, a red/green confidence light and (depending on the version purchased) a remote socket for connecting ancillary devices such as tail call leads and pressure pads. The type of call point used will depend on the type of operation (button or magnetic reset) and the system features you wish to take advantage of. For example, if you wish to utilise Quantec's Call Follower Sounder option, call points with sounders should be used. Likewise, if you want to make calls with infrared transmitters, call points with infrared receivers should be used.

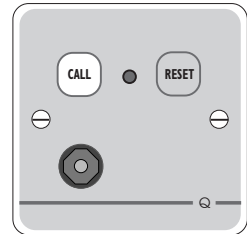

Note: infrared coverage may not be required in all rooms and infrared ceiling receivers are also available.

QT602 Range Call Points (include remote sockets)

- QT602 Quantec call point, button reset
- QT602S Quantec call point, button reset with sounder
- QT602R Quantec call point, button reset with I/R receiver
- QT602RS Quantec call point, button reset with sounder & I/R receiver
- QT602M Quantec call point, magnetic reset
- QT602SM Quantec call point, magnetic reset with sounder
- QT602RM Quantec call point, magnetic reset with I/R receiver
- QT602RSM Quantec call point, magnetic reset with sounder & I/R receiver

QT609 Range Call Points (do not include remote sockets)

- QT609 Quantec call point, button reset
- QT609S Quantec call point, button reset with sounder
- QT609R Quantec call point, button reset with I/R receiver
- QT609RS Quantec call point, button reset with sounder & I/R receiver
- QT609M Quantec call point, magnetic reset
- QT609SM Quantec call point, magnetic reset with sounder
- QT609RM Quantec call point, magnetic reset with I/R receiver
- QT609RSM Quantec call point, magnetic reset with sounder & I/R receiver

Magnetic Reset Keys

- NC803M/10 Pack of 10 magnetic reset keys
- NC803M/50 Pack of 50 magnetic reset keys

MONITORING POINTS

Monitoring points have one button, a red/green confidence light and an isolation keyswitch to prevent operation when a door is to be left open. If required, fire exits, doorbells, telephones, drug cupboards, etc, can be connected so that operating them makes a standard or emergency call. Door contacts are not supplied.

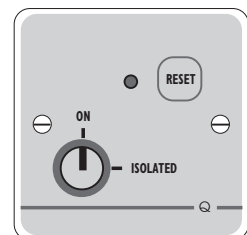

- QT604 Quantec Monitoring Point, button reset
- QT604M Quantec Monitoring Point, magnetic reset

DISPLAYS

Quantec's displays scroll automatically and only show the calls which are the most urgent plus a message saying how many calls are waiting on that part of the system. Therefore, if there are no calls, the displays will show the time, then Staff Presence calls, Standard calls, Help Required calls, Emergency calls & Attack calls. They have an A (accept) button, plus buttons to control divert and other features. Displays with no controls are also available.

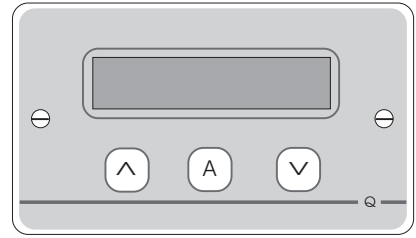

- QT608C Quantec Corridor Display, with controls
- QT608CD Quantec Corridor Display, no controls

INFRARED CEILING RECEIVERS

Infrared ceiling receivers are designed for use with Quantec's wide range of infrared transmitters (see page 10). They are usually located in bedrooms, corridors, common rooms and any other internal area that requires infrared coverage. Slave infrared ceiling receivers are also available (up to three per master infrared ceiling receiver or infrared call point) to improve coverage in 'L' shaped rooms, etc. Dependent on the type of transmitter(s) used, master ceiling receivers allow standard and/or attack calls to be made (both levels of call can be reset by entering a special code at the Quantec Controller or a corridor display). The type of calls that can be made from a slave ceiling receiver will depend on whether they are connected to a master ceiling receiver (standard and attack calls only) or an infrared call point (standard, help required, emergency and/or attack calls).

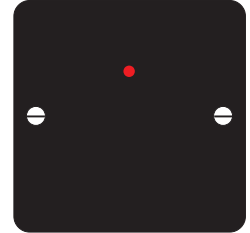

- QT302RX Master Infrared Ceiling Receiver
- QT302RXS Slave Infrared Ceiling Receiver
- QT302RT Test Infrared Ceiling Receiver

RADIO RECEIVERS

Radio receivers are designed for use with Quantec's QT412 range of dual action infrared/radio transmitters (see page 10). Dependent on the transmitter(s) used, they allow standard and/or attack calls to be made from external areas such as car parks, loading bays, etc., (both levels of call can be reset by entering a special code at the Quantec Controller or a corridor display). Receivers must be mounted internally - typically in a building's roofspace - where they can provide RF coverage of typically 60m (dependent on conditions/location). An optional RF extension aerial is available for outdoor use and we recommend this for sites where the receiver is located close to large metallic objects or thick structural walls. In some cases external aerials can increase a receiver's RF coverage to typically 90m. For areas such as large car parks, it is not uncommon for multiple radio receivers to be used (for example, on adjacent walls) to ensure sufficient coverage.

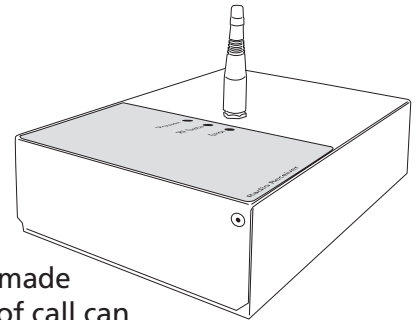

For sites with multiple, separately-managed areas, different radio receivers can be set up to respond to calls from certain transmitters only. This is done via an RF grouping facility whereby a receiver in, say, RF group 3, will only respond to transmitters assigned to the same RF group. The default setting for all radio receivers and transmitters is RF group 1 (of 16).

To help ensure the integrity of Quantec radio receivers, we recommend at least one monitored **RF Integrity Transmitter** is used with every radio receiver. Supplied on a single gang plate, they work by sending a periodic test transmission to the radio receiver. If the receiver fails to receive the test signal, it sends a fault message to the Quantec Controller to advise that something is wrong.

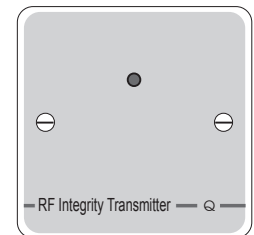

- QT422RX Quantec Radio Receiver
- QT422RXEX External Extension Aerial for Quantec Radio Receiver
- QT421 RF Integrity Transmitter

ADDRESSABLE OVERDOOR LIGHTS & ADDRESSABLE SOUNDERS

Addressable overdoor lights are designed to act as area indicators or to provide 'follow me' lights at the ends of corridors, etc. They have built-in sounders and are similar in appearance to standard overdoor lights. Because they are addressable, they can be instructed to light when certain groups of call points are calling. Addressable sounders can be used to increase sound levels in long corridors, outside communal areas, etc.

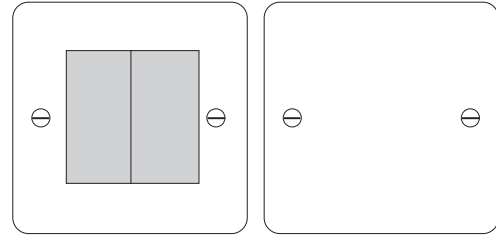

QT606A Quantec Addressable Overdoor Light
QT688 Quantec Addressable Sounder

QUANTEC CONTROLLER

The Quantec Controller supplies power to and controls the Quantec system. It constantly monitors all network devices and indicates the exact ID number of any faulty devices. Connections are provided at the controller for all network wiring, optional stand-by batteries and various system ancillaries including printing, paging and programming equipment. It is supplied in a 410 x 250 x 80mm metal back box and can be flush or semi-flush mounted using the AFP385 mounting bezel.

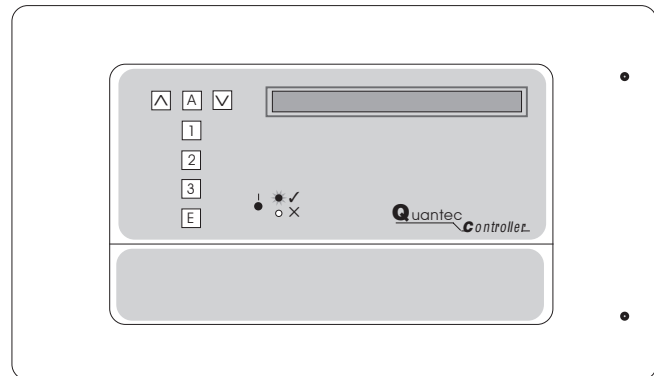

Programming is usually carried out via a laptop PC running Quantec's upload/download PC software (part no. QT707). The buttons on the controller's front can also be used for programming but as this is very time consuming we recommend it for updating existing site data only.

In addition to the controller's library of 45 pre-set place names, up to 40 custom place names (of up to 11 characters) can be programmed into the Controller for assigning to network devices. The library of 45 pre-set names consists of the following:-

Annex; Area; Bathroom; Bedroom; Conservatory; Corridor; Dining room; Disabled WC; Display; Door; Doorbell; Drugs Cab; Entrance; ESMI Unit; Exit; Fire exit; Flat; Floor; Gents WC; Hair-dresser; Kitchen; Ladies WC; Laundry; Lift; Lounge; Meeting RM; OD Light; Phone; Quiet Room; Reception; Room; Shower; Sluice; Special; Staff Room; Toilet; Treat Room; TV Room; Ward; Zone

Up to four alphanumeric characters can be tagged onto the end of all pre-set and custom place names, a typical example being: "DISABLED WC EW01".

The Controller's 40x2 character display is effectively split into two parts, the left side showing the time, date and call information; the right side continually showing the overall status of the system and providing notification of any faults.

To assist the engineer at system setup and during routine maintenance, a wide range of installation and fault finding functions are also provided at the Controller. These are described in greater detail in the Quantec Programming Manual (doc. no. DNU6012001)

QT601-2 Quantec Controller
AFP385 Bezel for QT601-2 Quantec Controller
QT707 Quantec Programming Kit (incl. upload/download software & lead)
QT600P Quantec Printer Kit (incl. pre-tested printer, wall socket and lead)
DP874QA 400m Alphanumeric paging transmitter (incl. transmitter, wall socket & lead)
DP877QA 32 character alphanumeric display pager, group A.

Please refer to our Quantec price list for additional alphanumeric paging equipment such as extension aerials, mounting brackets and low loss cable.

ANCILLARY DEVICES

SLAVE OVERDOOR LIGHTS

Slave overdoor lights comprise two red and two green ultra-bright LEDs inside a triangular diffuser. They offer low current consumption and connect to call points via four cores (Two cores are the same as the two network wires so connection to the network can be made at the overdoor light or the call point).

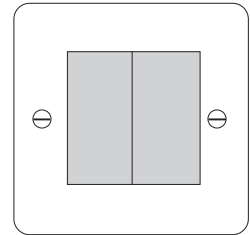

QT606 Quantec Overdoor Light

CEILING PULLS

Ceiling pulls have a red confidence light and a 3m cord with two open-sided triangular pulls specially designed for ease of use by the infirm. Four knockouts are provided for 16mm square mini trunking and the backplate fits BESA centres. They are generally reset at a call point to which they connect via three cores.

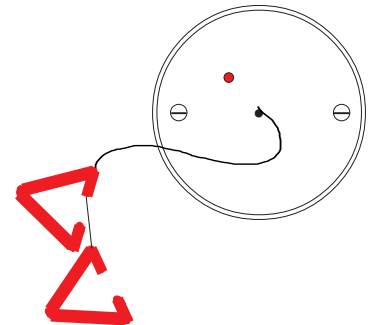

QT607 Quantec Ceiling Pull

SLAVE CALL POINTS

Slave call points are functionally the same as ceiling pulls and as such must be used in conjunction with a master call point. Comprising a call button, remote socket and confidence light, they are designed for use in areas such as double bedrooms where more than one call button may be required. All calls must be reset at the master.



QT602D Quantec Slave Call Point

TAIL CALL BUTTONS

Tail call buttons consist of a pear-shaped push, a lead and a plug that connects it to a call point's remote socket. A call is made by pressing the button or by pulling the plug out. Tail call leads are available in a variety of different lengths (as indicated below) to suit different applications.

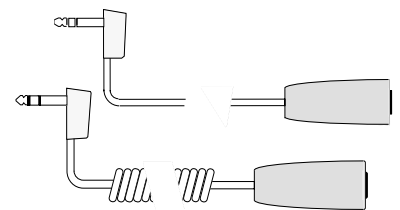

NC805C/6 1.8m (6ft) tail call button with right angle plug
NC805C/14 4.2m (14ft) tail call button with right angle plug
NC805D 1.2-3.6m (4-12ft) tail call button with coiled lead

HAND/FOOT OPERATED PNEUMATIC PADS

Ideal for patients who find it difficult to press buttons, Quantec's hand/foot operated pneumatic pad must be used in conjunction with the NC805AS air switch.

Applying pressure to the pad operates the air switch which, when connected to a call point's remote socket, triggers a call.



NC805P Hand/Foot Operated Pneumatic Pad
NC805AS Remote Air Switch, for use with NC805P

PORTABLE MOVEMENT DETECTORS

A simple to operate adjustable weight sensor which sits under the leg of a bed and connects to a call point's remote socket via a jack plug. A call is triggered when the bed is vacated, thus alerting staff to the prospect of a wandering patient.

NC805MD Portable Movement Detector

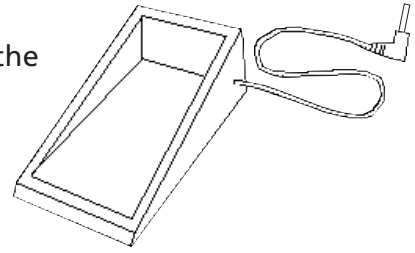

DUAL-ACTION INFRARED/RADIO TRANSMITTERS

Quantec's new QT412 range of rechargeable dual-action infrared/radio transmitters have a typical infrared transmitting range of 10m (line of sight) and a typical radio transmitting range of around 60m.



Each transmitter has two infrared emitters (one on each side to maximise performance), two buttons (A & B) and a retained 'pull clip'. Depending on its configuration, pressing a transmitter's buttons or activating its 'pull clip' will generate a standard, help required, emergency or staff attack call on a compatible Quantec infrared and/or radio receiver.

Housed in a tough plastic enclosure, each transmitter provides battery low indication as standard and can be recharged fully in approximately 14 hours using the QT424/1 single way charging unit. A ten way charging unit, the QT424/10, is also available for sites with multiple transmitters.

Two pre-configured transmitters are available, the QT412RXA push for attack/pull for attack transmitter and the QT412RXCA push for call/pull for attack transmitter. If a different transmitter configuration is required, the QT423 configurator (described below) will allow an engineer to reprogram any of the above transmitters to suit the operational requirements of an individual site.

QT412RXA Dual action infrared/radio transmitter (configured for push for attack/pull for attack)

QT412RXCA Dual action infrared/radio transmitter (configured for push for call/pull for attack)

QT424/1 Single way battery charging unit for QT412 range transmitters

QT424/10 Ten way battery charging unit for QT412 range transmitters

CONFIGURATOR FOR QT412 RANGE DUAL-ACTION TRANSMITTERS

The QT423 configurator allows the operation of any QT412 range transmitter to be tailored to suit the requirements of a specific site. In particular it allows authorised engineers to :-

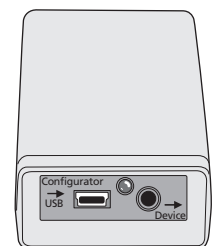

- Assign the level of call that will be triggered when the transmitter's A button is pressed.
- Assign the level of call that will be triggered when the transmitter's B button is pressed.
- Assign the level of call that will be triggered when the transmitter's 'pull clip' is activated.
- Set the transmitter's A & B buttons so they only trigger a call when both are pressed simultaneously.
- Turn the transmitter's on-board 'confidence' beeper on or off.
- Turn the transmitter's radio action off.
- Set the transmitter's transmission time to run continuously or to automatically switch off after a pre-determined time .
- Assign the transmitter an RF group ID address (1 to 16) to match the setup of any Quantec radio receivers on the system - see RADIO RECEIVERS, page 7, for further details.
- Change the transmitter's mode of infrared transmission to 'pulsed' to suit older Quantec systems.

Each configurator comes with a programming CD (Windows 2000/XP compatible), a USB connection lead (to connect the configurator to a PC) and a lead for connecting the configurator to a QT412 range transmitter for programming.

QT423 Quantec Configurator

PLANNING AN INSTALLATION

Although Quantec far exceeds the minimum requirements of all agencies, rules regarding installation may vary depending on the area of the country. If there is any doubt, please check with the relevant authorities/building management.

The Quantec Controller can be located anywhere on the network although it is usually installed centrally to reduce wiring runs or in the manager/matron's office. When not being used for programming, it operates in exactly the same way as a display.

Displays should be located strategically around the premises where they can be readily seen by staff, in areas such as junctions in corridors, staff rooms, etc.

In nursing home/hospital type applications, **Call Points** should be sited next to each bed (preferably above bedhead height to avoid damage to them when the bed is moved) and in lounges, dining rooms and other communal areas. In other applications such as leisure centres, prisons, etc, they should be installed as advised by the client.

Ceiling Pulls should be fitted in each bathroom and WC.

Slave Overdoor Lights (if required) are normally installed outside rooms.

If area indication or 'follow me' lights are required, **Addressable Overdoor Lights** should be positioned at the ends of corridors, above fire doors, etc.

Monitoring Points should be fitted close to fire exits, drug cupboards or alongside any other area/device which needs to be monitored.

Infrared Ceiling Receivers/Call Points should be positioned in all areas which require infrared coverage. The number and type of devices used will vary depending on the application. Note that master infrared ceiling receivers can generate standard and/or attack calls only whereas infrared call points can generate standard, help required, emergency and/or attack calls. Slave ceiling receivers will generate the same levels of call as the master device they are connected to.

When deciding on the position of **Infrared Ceiling Receivers**, take into account the 10 metres line-of-sight transmitting range of infrared transmitters. Use slave receivers in large open areas, long corridors or 'L' shaped rooms where one master is unable to provide sufficient coverage. Where possible, position master receivers in central positions and look at the relevant sight lines. If any area of the room is out of sight of the receiver or is over 7 metres away from it, boost coverage with slave receivers. If in doubt, use slaves (up to three slaves can be used per master).

As **Infrared Call Points** are designed to be wall-mounted, pay particular attention to their height as furniture or ornaments added to the room at a later date could obstruct them. As with master infrared ceiling receivers, up to three slave receivers can be connected to one master infrared call point.

Note that different types of lighting and wallcovering can affect the range of infrared transmissions and rooms with excessively dark walls may require more infrared receivers than rooms with reflective walls. Avoid placing receivers in direct sunlight. (Remember, when surveying rooms that the sun's position changes and a room that is in the shade in the morning may not be in the shade in the afternoon). Watch out for corridors with lots of windows, conservatories and rooms with skylights - you may have to increase the number of receivers used to compensate for this. Also, avoid placing receivers too close to fluorescent lights and spot lights and be careful not to position them too close to smoke detectors, lampshades or PA speakers as these may obstruct any signals transmitted.

Radio Receivers should be mounted internally - typically in a building's roofspace - close to the area that requires RF coverage. Typical coverage (dependent on conditions) is around 60m per receiver, boostable to 90m if an external RF aerial is used. See Radio Receivers, page 7, for more detailed information.

PLANNING THE WIRING

Quantec can be compared to an analogue addressable fire alarm system where the integrity of the wiring is of paramount importance. However, with Quantec, a 'star' rather than a 'loop' wiring scheme is used.

In order to allow the use of ordinary unscreened cables and reduce the risk of volt drop, the only method of wiring Quantec we recommend involves the use of 'network splitters' (QT603).

Network splitters have six fused 'limbs' for the wiring of individual sections of the system and they provide a convenient way of wiring, testing and protecting the system. In addition to simplifying the wiring and reducing volt drop, their fault and power LEDs also help find installation faults.

Each splitter has one input and one output network connection (both unfused) and six 'limb' outputs that are fused. The unfused connections are for the connection of the network 'Spine' which should normally be wired in at least 1mm² cable (e.g. T&E). No other networked devices should be connected to the spine except network splitters. The fused outputs i.e. 'Limbs' are for the connection of individual circuits containing networked devices. These should be wired in four or six core security cable. In excess of 60 addressable devices can be connected to each network splitter. Consequently four splitters are capable of accommodating an entire system. However, for larger systems and for convenience it is likely that more will be used.

As network devices are 'soft addressed' after installation no consideration need be made as to how different network devices will interact with each other. Within rooms, however, ancillary devices must be connected to a call point and it is simplest to loop in and out of slave overdoor lights (if fitted). If slave overdoor lights are not fitted, loop in and out of call points. The diagrams below show how this should be done in nursing home-type applications, but the same applies to other buildings too.

DEVICE WIRING WHEN SLAVE OVERDOOR LIGHTS ARE USED

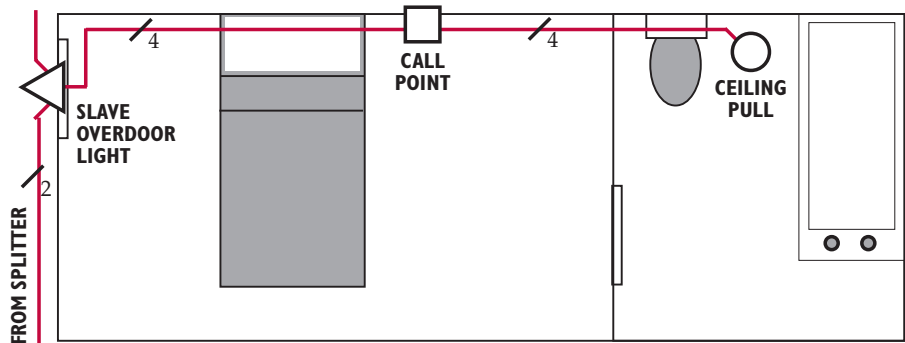

DEVICE WIRING WHEN SLAVE OVERDOOR LIGHTS ARE NOT USED

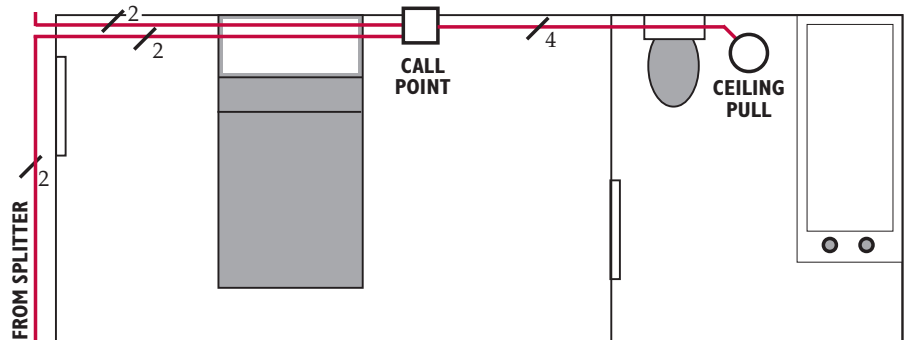

Comprehensive details on how to wire Quantec appear in our Quantec Wiring Instructions (doc. no. DNUQ171717). Please ensure your contractor obtains a copy and reads it carefully before work commences. Pre-Commissioning Instructions are also available (doc. no. DNUQ1818PRE).

EXAMPLE WIRING OVERVIEW

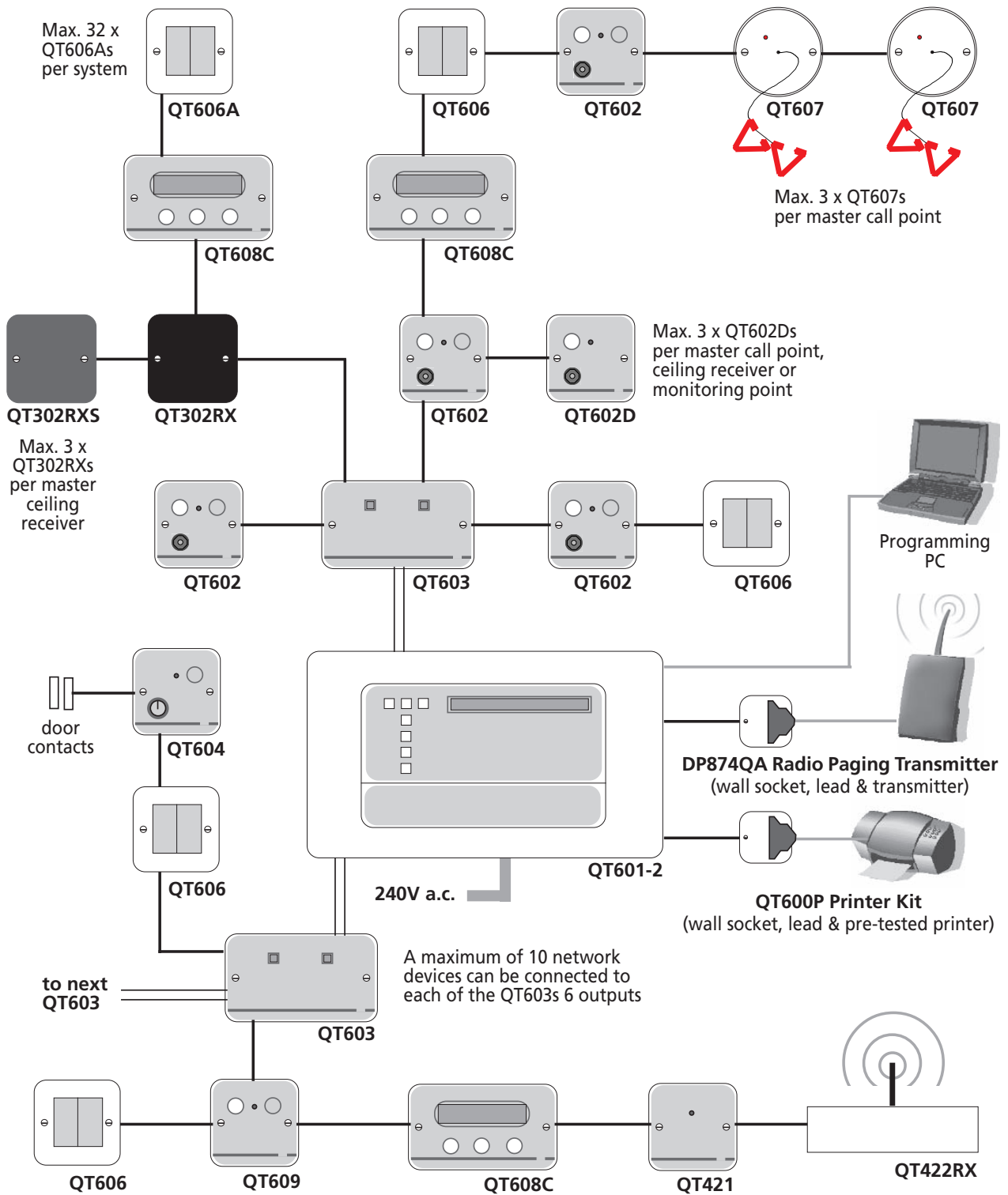

SPINE <hr/> 100m = 1.0mm ² twin and earth 150m = 1.5mm ² twin and earth 250m = 2.5mm ² twin and earth LIMB <hr/> 40m = 4 core stranded alarm cable 60m = 8 core stranded alarm cable	QT600S	Wall socket	QT607	Ceiling pull
	QT601-2	Quantec controller	QT608C	Display
	QT602	Master call point (with remote)	QT302RX	Master ceiling receiver
	QT603	Network splitter	QT302RXS	Slave ceiling receiver
	QT604	Monitoring point	QT421	Radio 'heartbeat' plate
QT609	Master call point (no remote)	QT422RX	Radio receiver	
QT606	Slave overdoor light	QT412RXA	Dual action transmitter	
QT606A	Addressable overdoor light		Other devices are available	

DEVICE DIMENSIONS

	Width	Height	Depth
Call points/monitoring points	87mm	87mm	35mm
Infrared ceiling receivers	87mm	87mm	35mm
Overdoor lights (addressable and slave)	87mm	87mm	60mm
RF integrity transmitter plate	87mm	87mm	25mm
Displays/network splitters	146mm	87mm	35mm
Ceiling pulls	93ømm	-	27mm
Infrared transmitters (main body)	45mm	115mm	25mm
Portable movement detectors	100mm	48mm	187mm
Pressure pads	93ømm	-	22mm
Quantec controller (back box)	410mm	250mm	80mm
Quantec controller (lid)	439mm	274mm	7mm
Radio receivers	271mm	155mm	170mm

All single gang devices (87mm x 87mm) mount on 25mm single gang UK back boxes.

All double gang devices (146mm x 87mm) mount on 35mm double gang UK back boxes.

Quantec Controllers are designed to be surface mounted or, alternatively, semi-flush mounted using the AFP385 bezel.

Radio receivers are designed to be surface mounted.

Ceiling pulls have four knockouts for 16mm square mini trunking and their backplate fits BESA centres.

All quoted dimensions are approximate.

FURTHER INFORMATION

Want to know more? Why not enquire about our free Quantec training courses?

Intended primarily for those working in engineering and sales, these intensive courses are designed to offer an in-depth understanding of the installation, maintenance and commissioning of the Quantec addressable call system.

Held regularly at the manufacturer's headquarters in the north west of England, each course lasts approximately four to five hours.

Please note that off-site training sessions can also be arranged for qualifying customers (minimum 6 delegates). Please contact your distributor for details.



Solid State

Tel: 01257 463018 **Fax:** 01257 462038

Email: sales@solidstatesecurity.co.uk

Visit our website at
www.solidstatesecurity.co.uk

© 1996-2005. Approved Document No: DNSQ100101 Rev 6. We reserve the right to alter product specifications at our discretion and without prior notice. Errors and omissions excepted. This guide has been carefully checked prior to publication. However, no responsibility can be accepted by the Manufacturer or Distributor(s) of the Quantec system for any inaccuracies or for any misinterpretation of an instruction or guidance note.